

Please complete form thoroughly. Missing information may delay order processing.

NOTE: ACI replacement tarps are custom made to your order and are non-returnable. Accurate PHYSICAL measurements are ESSENTIAL for proper tarp fit. Always use actual tape measurements. NEVER RELY ON UNIVERSAL BOX SIZES. Box size and finished tarp size are not the same.

DIMENSIONS OF THE TARP SYSTEM YOU CURRENTLY OWN

SPOOL ROLL TARP SYSTEM:

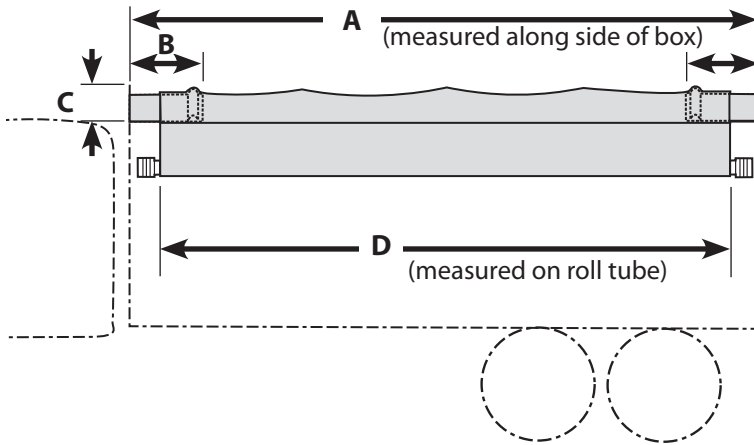

EZ-LOC® TARP/AUTOLOCK™ (LATCHPLATE STYLE) SYSTEM:

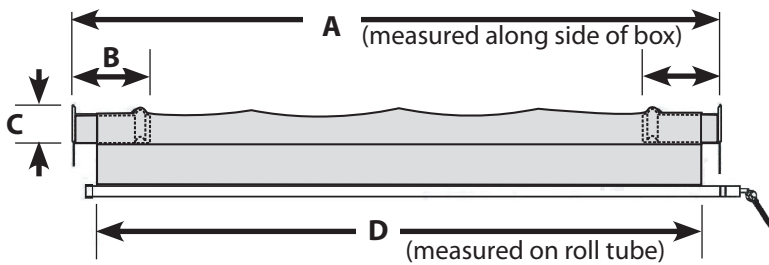

SHUR-LOK BRAND* TARP (LATCHPLATE STYLE) SYSTEM:

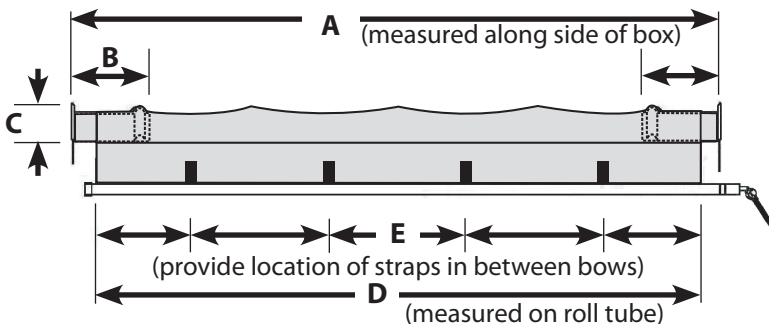

*SHUR-LOK is a Registered Trademark of Shur-Co (Shur Company, Yankton, SD). Agri-Cover, Inc. (ACI) is not related to or affiliated with Shur-Co and does not sell and is not offering to sell Shur-Co products.

Sales Representative: _____

CONTACT INFORMATION

Name _____
Address _____
City _____ State _____ Zip _____
Phone _____ Fax _____

TARP COLOR

Standard:

Black White

Optional:

Gray Blue Red Orange
 Green Brown Yellow Multi-Color

CONSTRUCTION BELLY DUMP TRAILER

Yes No

TYPE OF SPOOL ROLL TARP SYSTEM

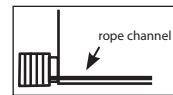

SRT-2A nylon spool aluminum roll tube w/rope channel

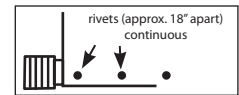

SRT-2™ nylon spool steel roll tube w/ rivets

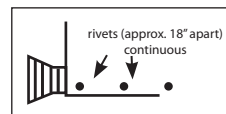

SRT-1 w/ tapered aluminum spool, steel roll tube w/ rivets
Select if: Seam Outside Seam Inside

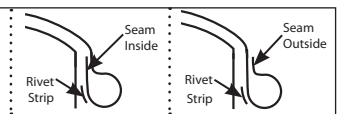

TYPE OF LATCHPLATE TARP SYSTEM



EZ-LOC®: tarp attaches to 2" roll tube with rope channel
 AUTOLOCK™ Electric: tarp attaches to 3" roll tube with rope channel



OTHER SYSTEMS: tarp attaches to roll tube w/ webbing straps and clips (fill in # of straps where shown)

MEASUREMENTS (Please check the system that you have and wish to replace)

- Spool Roll Tarp System
- EZ-LOC®/AUTOLOCK™ Tarp (Latchplate Style) System
- SHUR-LOK Brand* Tarp (Latchplate Style) System

A _____ Outside End Cap to End Cap
B _____ End Cap Width / _____ Front _____ Rear
C _____ End Cap Height
D _____ Finished Sewn Tarp Length
_____ Finished Sewn Tarp Width
E _____ How Many Straps (only if original tarp has them)
Box Width _____ Box Length _____